

TASTE SPACE

SECTION



Beauty bed series

ONE STOP SOLUTIONS FOR BEAUTY CLINIC

hochey

Reception desk series



Cart series

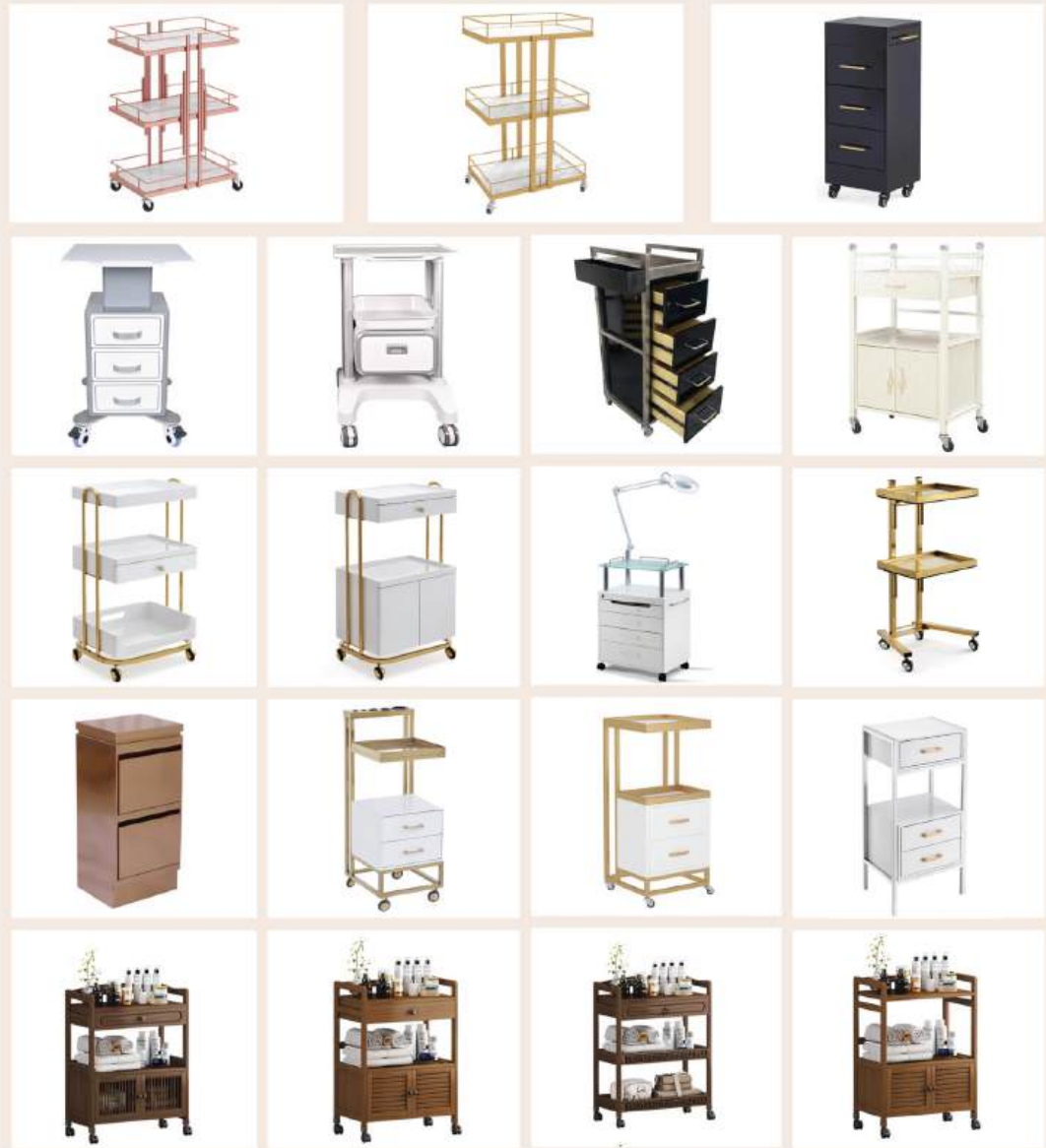



G06-A CE

- Material: Jicang motor, shaping sponge, high elastic sponge, waterproof leather, injection molded leg rest, ABS
- Functions: 4 motors, hand control + back key reset + foot control on both sides, 3 position memory functions, reset key and Lock key, adjustable head, foot control position on both sides can be moved, manual rotation 240
- Size: 1890x850x(640-980)mm
- Packing size: 137*80*82cm
- Gross weight: 105kg
- A minimum order of 5 units is required



G06-B CE

- Material: Jicang motor, shaped sponge, high elastic sponge, waterproof leather, ABS
- Function: 4 motors, hand control + control buttons on the back and seat side + foot control on both sides 3 position memory function, reset button and Lock key, adjustable head, both sides of the foot control position can be moved, manual rotation 240
- Size: 1890x850x(640-980)mm
- Packing size: 137*80*82cm
- Gross weight: 105kg
- A minimum order of 5 units is required



G06-C CE

- Material: Jicang motor, shaped sponge, high elastic sponge, waterproof leather, ABS shell
- Function: 4 motors, hand control + control buttons on the back and seat side, 3 position memory functions, reset key and Lock key, adjustable head, manual rotation 240
- Size: 1890x850x(640-980)mm
- Packing size: 137*80*82cm
- Gross weight: 105kg
- A minimum order of 5 units is required



D10-6 CE

- Material: waterproof leather, metal bracket, high elastic sponge, Solid wood multi-layer board
- Function: Electric 4 functions. With 3 position memory functions
- Optional: leather color, Heating
- Product size: 200*78*85CM
- Packing size: 204*88*81 1.42 sq
- Gross weight: 95kg



D11-3 CE

- Material: CE certified motor, waterproof leather, metal bracket, high elastic sponge, solid wood multi-layer board
- Function: Electric 4 function control lifting - legs-back - forward and backward tilt + one-key reset + one-key linkage + one-key lock
- Optional: heating, foot control
- Product size: 197*77*73-88
- Packing size: 204*82*85
- Gross weight: about 100kg



G09 CE

- Material: ABS, waterproof leather, metal bracket, high elastic sponge + 4cm latex mattress
- Function: Electric 4 functions
- Controllable position: overall lifting, back, legs, front and back tilt
- Optional: leather color, heated
- Product size: 182*80*65-85
- Package size: 220*87*84
- Gross weight: 120kg



G12 CE

- Material: Jicang motor, waterproof leather, shaping sponge
- Function: 3 motors
- Adjustable position: height, backrest, leg plate, flexible adjustment by motor
- Product size: L1890xW810xH(590-880)mm
- Packing size: 182*65*77
- Gross weight: 80kg
- A minimum order of 5 units is required



G13 CE

- Material: Jicang motor, waterproof leather, shaping sponge
- Function: 5 motors
- Adjustable position: height, backrest, tilt, legs apart, multi-angle leg design, flexible adjustment through the motor
- Product size: L1780xW830xH(630-975)mm
- Packing size: 132*80*90
- Gross weight: 95kg
- A minimum order of 5 units is required



G01 CE

- Material: ABS, waterproof leather, metal bracket, high-density shaping sponge
- Function: 4 motors, with heating, light, airbag, memory, with hand control + foot control rubber band holster
- Optional: Leather color
- Product size: 179*84.5*81
- Packing size: 120*73*77=94kg
- A minimum order of 5 units is required



G08 CE

- Material: electroplated stainless steel, waterproof leather, metal bracket, high elastic sponge, ambient lighting
- Function: Electric 4 functions
- Controllable position: overall lifting, back, legs, front and back tilt
- Options: leather, metallic, heated
- Product size: 193*77*86-90
- Packing size: 200*85*82
- Gross weight: 110kg



D11-1 CE

- Material: CE certified motor, stainless steel, waterproof leather, metal bracket, high elastic sponge, solid wood multi-layer board
- Function: Electric 3 functions can control lifting-legs+back
- Optional: Heating
- Product size: 197*77*68-82
- Package size: 205*87*84 (slats + forklift feet)



D11-2 CE

- Material: CE certified motor, stainless steel, waterproof leather, metal bracket, high elastic sponge, solid wood multi-layer board
- Function: electric 3 function lifting, legs, back + one-key reset + one-key linkage + one-key locking
- Optional: Heated - foot control
- Product size: 197*77*73-88
- Packing size: 205*83*92
- Gross weight: 95kg



G11 CE

- Material: electroplated stainless steel, waterproof leather, metal bracket, high elastic sponge.1
- Function: Electric 4 functions + bilateral foot control
Controllable position: overall lifting, back, legs, front and back tilt
- Options: leather, metallic, heated
- Product size: 190*77*66-87
- Packing size: 200*85*62
- Gross weight: 110kg



D-11C CE

- Material: Waterproof leather, galvanized stainless steel, high-stretch sponge
- Function: Electric 3 functions
- Optional: foot control, heating, leather color, metal color, pneumatic double armrest
- product dimensions: 190*80*66-81
- package size: 200*90*72



D-11A CE

- Material: Waterproof leather, galvanized stainless steel, high-stretch sponge
- Function: Electric 3 functions
- Optional: foot control, heating, leather color, metal color
- product dimensions: 190*72*60-85
- package size: 202*82*70
- Weight: 120KG (without feet)
- Standard: FHR, TOCO, FM
- Optional: Twins.FAS(Fetal acoustic simulator)



D15 CE

- Material: CE certified motor, electroplated stainless steel, waterproof leather, metal bracket, high elastic sponge, solid wood multi-layer board
- Function: electric 2 function controllable lifting, back, head therapy + foot massage + facial beauty
- Package size: 211*70*85) with forklift feet
- Net weight: (108 kg)



D18 CE

- Material: electroplated stainless steel, high resilience memory foam, waterproof and wear-resistant leather, ambient lighting, acrylic foot bath
- Function: Electric 2 function
- Optional: foot bath, metallic, leather
- Product size: 190*80*60
- Packing size: 200*90*78



D11 CE

- Material: Waterproof leather, stainless steel, high stretch sponge
- Function: Electric 4 functions
- Optional: foot control, heating, leather color, metal color
- product dimensions: 190*77*63-83
- Packing size: 200*90*72
- Gross weight: 110kg



G04 CE

- Material: stainless steel, waterproof leather, metal bracket, high elastic sponge
- Function: Electric 3 functions + heating + ambient light
- Product size: 205*85*68-85
- Packing size: 220*100*85cm
- Gross weight: 130kg



D17 CE

- Material: electroplated stainless steel, high-density sponge, waterproof leather, solid wood multi-layer board
- Function: Electric 3 functions
- Optional: 4 motors, Revolve, Vibration massage, Leather color, Heating, Metallic color
- Product size: 167*70*63
- Packing size: 161*76*70 90KG



D9-4 CE

- Material: electroplated stainless steel, high-density sponge, waterproof leather, solid wood multi-layer board
- Function: Electric 3 functions
- Optional: 4 motors, Revolve, Vibration massage, Leather color, Heating, Metallic color
- Product size: 167*70*63
- Packing size: 161*76*70 90KG



D10-15 CE

- Material: stainless steel, waterproof leather, metal bracket, high elastic sponge, solid wood multi-layer board
- Function: Electric 3 functions + foot control
- Product size: 190*67*60-80cm
- Packing size: 135*70*78cm
- Weight: 95.5kg



D9 CE

- Material: electroplated stainless steel, high-density sponge, waterproof leather, iron frame, Solid wood multi-layer boards
- Function: Electric 4 functions, manual rotation
- Optional: Leather color, heating, foot control
- Product size: 180*62*60-86
- Packing size: 159*70*74 wooden frame



D10-11 CE

- Material: ABS, waterproof leather, metal bracket, high elastic sponge
- Function: Electric 3 functions
- Optional: 4 motors, heating, foot control
- Product size: 214*56*60-80
- Packing size: 167*67*85
- Gross weight: 80kg



D9-3 CE

- Material: electroplated stainless steel, waterproof leather, solid wood multi-layer board, high-density sponge
- Function: Electric 3 functions
- Optional: 4 motors. Leather color: Heating. Foot control. Metallic color
- Product size: 194*65*65-78
- Packing size: 133*70*70 wooden frame



D7-F CE

- Material: stainless steel, high-density sponge, waterproof leather, solid wood multi-layer board
- Function: Electric 3 functions
- Optional: leather color. Metallic color. Heating. Foot control
- Product size: 200*65*90-85
- Packing size: wooden frame 168*70*77



D7-L CE

- Material: ABS, waterproof leather, metal bracket, high-density sponge. Solid wood multi-layer board.
- Function: Electric 3 functions
- Optional: 4 motors. Leather color. Heating. Foot control
- Product size: 203*64*62-90
- Packing size: 167*70*70cm



G14 CE

- Material: waterproof leather, metal bracket, ABS shell, shaping sponge
- Function: electric 3 functions + seal bag side control
- Controllable position: leg back linkage, backward tilt, lifting
- Packing size: 172*72*75
- Gross weight: about 80kg



D7-I CE

- Material: ABS, waterproof leather, metal bracket, high-density sponge. Solid wood multi-layer board.
- Function: Electric 3 functions
- Optional: 4 motors. Leather color: Heating. Foot control
- Product size: 200*60*80-85
- Packing size: 166*70*67cm wooden frame 0.77
- AC or LI-battery operated
- More than 12 hours data storage, then can be played and reprinted
- Built-in interface to the central nurse station



D-5-2 CE

- Material: stainless steel iron frame, high elastic sponge, waterproof leather. Solid wood multi-layer boards
- Function: Electric 1 function
- Optional: 2 motors. Foot control. Leather color. Metallic color. heating
- Product size: 181*68*60-75
- Packing size: 165*70*65cm 0.83 square meters



D7-N CE

- Material: ABS, waterproof leather, metal bracket, high-density sponge. Solid wood multi-layer board.
- Function: Electric 3 functions
- Optional: leather color. Heating. Foot control
- Product size: 200*60*65-82
- Package size: 148*67*68cm wooden frame 0.68 square meters



D7-E CE

- Material: ABS, waterproof leather, metal bracket, high-density sponge
- Function: Electric 3 functions
- Optional: leather color. Heating. Foot control
- Product size: 195*81*60
- Packing size: wooden frame size 160*74*66cm



D10-13 CE

- Material: ABS, waterproof leather, metal bracket, high elastic sponge, solid wood multi-layer board
- Function: Electric 4 functions
- Controllable positions: lift, legs, back, leaning
- Optional: heating, foot control
- Product size: 205*80*64-80
- Packing size: 166*70*67 (0.77 sq.)
- Weight: gross weight 75kg



D-10 CE

- Material: Waterproof leather, iron frame, high stretch sponge, ABS shell
- Function: Electric 3 function, armrest removable
- Optional: color optional, 1, 2, 3 motors optional
- product dimensions: 180*62*60-86
- package size: Wooden frame 168*70*67



D6-1 CE

- Material: Waterproof leather, iron frame, high-stretch sponge
- Function: Electric 3 function, manual hydraulic rotation
- Optional: Color split leg function
- product dimensions: 160*60*58-70
- package size: 120*70*83



D5-1A CE

- Material: (Jiscang) medical-grade motor, large thrust, good stability, waterproof and wear-resistant leather, high resilience memory foam
- Function: Electric 2 function can carry ≥ 280kg
- Product size: 650*1960*580-800
- Packing size: 1990*680*590
- Gross weight: 110kg

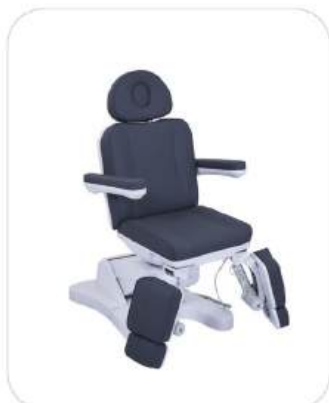

D10-1A CE

- Material: ABS, waterproof leather, metal bracket, high-density sponge, Solid wood multi-layer boards
- Function: Electric 5 functions
- Optional: leather color, Heating, Foot control
- Product size: 195*80*61-91
- Package size: 157*79*68
- Gross weight: 107KG



D-10A CE

- Material: ABS, waterproof leather, metal bracket, high-density sponge, Solid wood multi-layer boards
- Function: Electric 5 functions
- Optional: leather color, Heating
- Product size: 190*57*65-90
- Package size: 150x75x70



D12 CE

- Material: ABS, waterproof leather, metal bracket, high-density sponge, Solid wood multi-layer boards
- Function: Electric 3 functions
- Optional: 1/4 motor, Leather color, Heating, Foot control, wheel
- Product size: 180*62*56-76
- Packing size: 160*70*82
- Gross weight: 70kg

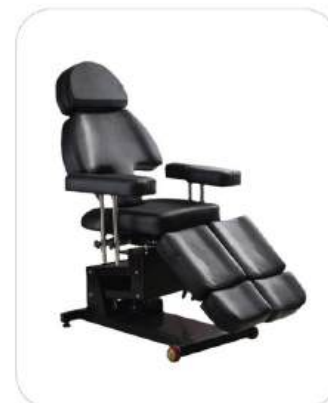

D6 CE

- Material: Waterproof leather, iron frame, high-stretch sponge
- Function: Electric one function, non-rotatable
- product dimensions: 185*63*60-72
- package size: 141*75*72



D6B CE

- Material: Waterproof leather, iron frame, high-stretch sponge
- Function: Manual hydraulic rotatable, electric non-rotatable
- product dimensions: 185*63*60-72
- package size: 141*75*72

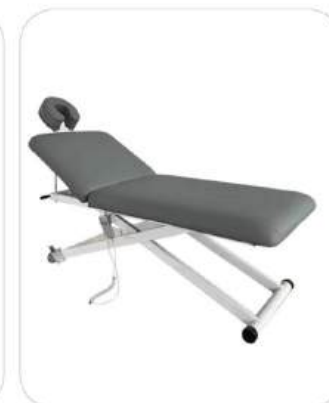

A functional examination bed



D8-1 CE

- Material: ABS, waterproof leather, metal bracket, high-density sponge, Solid wood multi-layer boards
- Function: Electric 4 functions, manual rotation
- Optional: 4 motors, Leather color, Heating, Foot control, Mood lighting
- Product size: 190*63*69-88
- Packing size: 142*78*69 wooden frame



D11-9 CE

- Material: ABS, waterproof leather, high-elastic sponge, ABS, solid wood multi-layer
- Function: 3 functions, respectively control lifting, back lifting, leg lifting
- Optional: 4 motors, color, foot control
- Packing size: 168*70*72
- Gross weight: 75kg



D10-1 CE

- Material: Waterproof leather, solid wood multi-layer board, high elastic sponge
- Function: Electric 1 function
- Optional: Colors are optional
- product dimensions: 180*75*63
- package size: 135*60*70



D13 CE

- Material: solid wood multi-layer board, waterproof leather, gold-plated feet, high-density sponge
- Product size: 190*80*90
- Packing size: 208*90*65
- Gross weight: 66kg



D11-6 CE

- Waterproof leather or flannel, high-stretch sponge, metal bracket
- Packing size: 192*45*73 (carton size)



Eyelash bed



D19-22 CE



D19-22B CE



D19-22C CE



D19-38 CE



D19-30 CE



D19-36 CE



D19-2 CE



MT-ET023 CE



D19-29 CE



D19-16 CE



D19-19 CE



D19-41 CE



D19-3 CE



D19-31 CE



D19-33 CE



D19-1 CE



D19-27 CE



D19-43 CE

**SCALP SHOULDER NECK MANAGEMENT
ALL-IN-ONE MACHINE**



HQ-L7B

Product efficacy **CE**

Scalp detection, intelligent analysis of cloud database,
Push the test report with one click,
Scalp care, hair care,
Shoulder and neck care for relaxation and adjustment.

3D FACE DETECTOR

HQ-L7B

CE Product efficacy

Top 10 items for accurate skin analysis
| Moisture content | Oil level
| Skin Texture | Pigmentation
| Red Blood | Pore status
| Acne Status | UV spots
| Brown Zone | Red Zone



**COMPREHENSIVE SCALP MANAGEMENT
INSTRUMENT (STAND-ALONE)**

HQ-L5D

Product efficacy **CE**

SCALP DETECTION+SCALP CARE
Nourishing Hair
Activate pores
Products Import
Shrink Pores



808 soprano hair removal device

HQ-808

Product efficacy **CE**

Painless Icy Hair Removal
Nourishing Hair
Firming And Rejuvenating Skin
Products Import
Improves Enlarged Pores And Rough Skin
Improves Facial Dullness
Improves facial radiance and elasticity



Beauty guide



HQ-H10

Product efficacy **CE**

- Moisturizes and locks in moisture
- Whitening and skin rejuvenation
- Tightens the skin , Shrinks pores , Removes wrinkles
- Use with the serum to allow the skin to absorb better

17-IN-1 SYNTHESIZER

HQ-WA16

CE Product efficacy

- Lifting and firming
- Acne and darkening
- Hydrate with oxygen and hydration
- Brightens and brightens the skin
- Deep cleansing
- Promotes absorption



Body contouring device

HQ-BD400

Product efficacy **CE**

- Aging skin, sagging, sagging, double chin
- Fat reduction and body contouring
- Beautiful legs
- Unclog the meridians



7-IN-1 ALICE SUPER BUBBLES

HQ-W07MAX

Product efficacy **CE**

- Shrinks pores
- Firming and shaping
- Cleansing, whitening
- Anti-aging and wrinkle removal
- Lightens fine lines, eye lines





White beauty beauty skin bubbles

HQ-WX9

Product efficacy **CE**

Clean the mites, improve the skin dull and texture.
 Deep clean the skin as well as getting rid of facial fluorescer, at the same time moisturizing and supplying nutrients to the skin.
 Cleaning the black and white head, improve skin relaxation, fine pores and increase skin transparency.

7-in-1 Hydrogen and Oxygen Small Bubbles (Face Mask)

HQ-W05X

CE Product efficacy

Skin Tightening Firming skin Filling skin cells
 Blackhead acne Pore cleaning
 Deep cleaning Smooth Skin
 improve immunity
 Anti-allergy Soothing repair



Nine-in-one space oxygen and hydrogen analyzer

HQ-WQ8

Product efficacy **CE**

Lifting and tightening
 Import absorption
 Deep hydration
 Excreting toxins Beautiful legs



Black Sand 2.0 Beauty Guide

HQ-H10

Product efficacy **CE**

No syringe, more safe ampoule more facility,
 With auto adjustment device when touch skin Firming
 Patented weight loss device can better solve the problem of forehead pain





Hydra Star 9-in-1 Super Bubble

HQ-WX9

Product efficacy **CE**

- BubbleCleaning
- Vacuum negative pressure with negative pressure suction to take all the dirty stuff away from the face
- non-invasive

Alice Super Bubbles

HQ-WO7MAX

CE Product efficacy

- Dig deep into pores to remove dirt and sweep out
- makeskin clean
- white and tender skin and blackheads



Astronaut nine-in-one hydrogen oxygen bubble

HQ-WQ8

Product efficacy **CE**

- Cold&Hot skin handle
- BubbleCleaning
- High pressure oxygen injection
- Roller speed lift



Ash 6-in-1 Large Bubble (Visualization)

HQ-WX600V

Product efficacy **CE**

- priming the skin and improving the wrinkles.
- Bubble Cleaning
- anti-allergy soothing repair
- Firming skin and filling skin cells



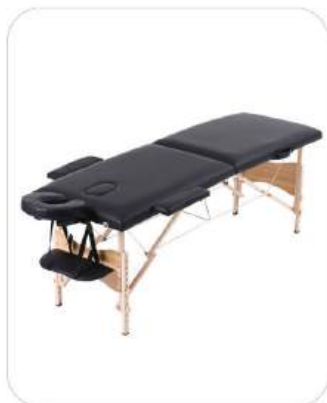

HQ-119

- Materials: PU/PVC Vinyl foam of 5cm thickness, beech wood
- Open Size: L185*W70*H62-87cm N.W./G.W.: 14KGS/17KGS
- Outlets: leather, metallic, heated
- Max working weight: 500lbs/227kgs/Carton
- Size: L95*W20*H75cm



HQ-116

- Material: stainless steel, waterproof leather, 5cm high elastic sponge
- Product size: 180*80*85cm
- Packing size: 93*95*21
- Gross weight: 13kg



HQ-117

- Material: stainless steel, waterproof leather, sponge, multi-layer board
- Product size: 180*80*85
- Packing size: 95*95*20
- Gross weight: 14kg



HQ-120

- Materials: PU/PVC Vinyl foam of 5cm thickness, beech wood
- Open Size : L185*W70*H62-87cm
- N.W./G.W.: 16KGS/19KGS
- Max working weight: 500lbs/227kgs/Carton
- Size: L95*W20*H75cm
- 20GP: 198 PCS 40GP: 408PCS 40HQ: 480 PCS



HQ-121

- Materials: PU/PVC Vinyl foam of 4cm thickness, alu frame
- Open Size: L185*W60*H60-81cm
- N.W./G.W.: 12KGS/15KGS
- Max working weight: 400lbs/180kgs
- Carton Size: L95*W18*H65cm
- 20GP: 248 PCS 40GP: 516PCS 40HQ: 580 PCS



HQ-118

- Materials: PU/PVC Vinyl foam of 5cm thickness, alu frame
- Open Size: L185*W70*H60-81cm
- N.W./G.W.: 15.5KGS/18.5KGS
- Max working weight: 400lbs/180kgs
- Carton Size: L95*W20*H75cm
- 20GP: 198 PCS 40GP: 408PCS 40HQ: 480PCS

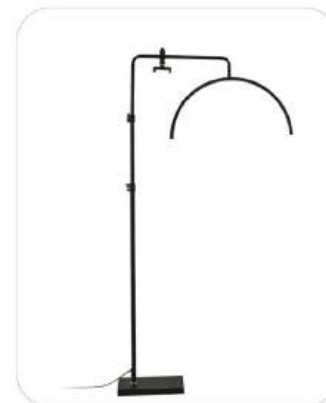

HQ-124

- Material: iron art paint
- Painting and polishing
- Foot switch, with remote control
- Light source: LED patch lamp bead
- With a phone stand
- The cap can be rotated 360° Height adjustment: 135-185cm
- Brightness and color temperature can be adjusted freely
- Suitable place: Beauty salon/hair salon/bedroom, etc

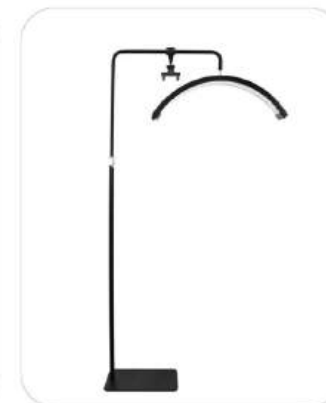

HQ-125 (STANDARD)

- Product name: Beauty Tattoo lamp/eyelash lamp
- Power: 30w
- Power supply: adapter
- Number of beads: 220
- Color rendering index: RA>90
- Voltage: 110V-240V/50-60HZ
- Size: 800*200*H1800mm
- Retractable height: 135-185cm
- Material: Aluminum alloy + PVC
- Brightness: stepless adjustment

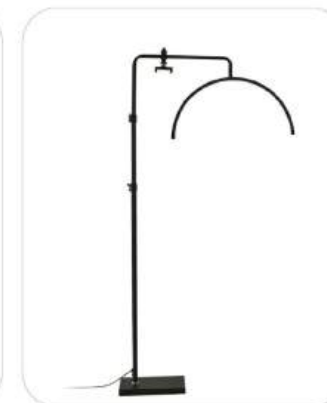

HQ-125 (UPGRADE)

- Product name: Beauty Tattoo lamp/eyelash lamp
- Power: 45W
- Power supply: adapter
- Number of beads: 320
- Color rendering index: RA>90
- Voltage: Input 110V-220V 50/60 Hz
- Size: Lamp, 28" half moon
- Telescoping height: The maximum telescoping height is 1.8M
- Material: Metal bracket + aluminum alloy lamp
- Brightness: stepless adjustment
- Color temperature: 3000-6000K



HQ-126

- Main materials: pine spray paint, glass, stainless steel cylinder
- Lamp power: 24w
- Lamp inner diameter: 12cm/Lamp
- Outer diameter: 23cm
- Cart: 65*55*35CM
- Lamp: 65*30*13CM Weight: 38KG

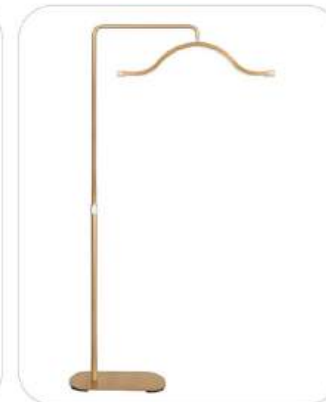

HQ-127

- Output power: 45W
- Power supply: Adapter
- Adjustment range: 0%-100%
- Color temperature: 3200K-5600K
- Color rendering index: RA>95
- Input power: 110V/240V 50Hz/60Hz
- Lumen: 2500LM
- Max. Height: 67.3 in / 171cm
- Min. Height: 39.7 inch / 101cm
- Color: Black, white, pink



HQ-128

- Power: 35W
- Color temperature: 5600K
- Number of lamp beads: 90 pcs
- Color rendering index: RA > 95
- Voltage: 110V/240V, 50Hz-60Hz
- Brightness: stepless adjustment
- Color: White

T A S T E S P A C E

hochey

TASTE SPACE

Nail art series

SECTION



Focus on nail art

ONE STOP SOLUTIONS FOR BEAUTY CLINIC

T A S T E S P A C E

Nail art collection



hochey
Manicure table and chair set

Wide table top
Easy to manage
Flannel fabric

MJ-2



Length options include 1.2m/1.4m/1.5m/1.6m/1.8m/2.0m

Nail art collection



hochey
Manicure table and chair set

Wide table top
Easy to manage
Flannel fabric

MJ-1



Optional: Leather material, vacuum cleaner, stainless steel material

hochey

Nail art collection



hochey
Nordic slate table and chair set

Ergonomic design
Bright rock slabs
Round-bottom design

MJ-3



Length options include 1.2m/1.4m/1.5m/1.6m/1.8m/2.0m

hochey

Nail art collection



hochey
Manicure table and chair set

Wide table top
Easy to manage
Flannel fabric

MJ-5/6



Optional: Leather material, vacuum cleaner, stainless steel material

hochey

Nail art collection



hochey

Nordic slate table and chair set

- Ergonomic design
- Bright rock slabs
- Round-bottom design

MJ-5B/6B



Length options include 1.2m/1.4m/1.5m/1.6m/1.8m/2.0m

hochey

Nail art collection



hochey

Manicure table and chair set

- Wide table top
- Easy to manage
- Flannel fabric

MJ-7



Optional: Leather material, vacuum cleaner, stainless steel material

Nail art collection



Chair series



Length options include 1.2m/1.4m/1.5m/1.6m/1.8m/2.0m



hochey

TASTE SPACE

Barbershop furniture



SECTION



Shampoo series

A one-stop solution for salon stores

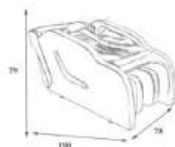

HQ-1

SIZE:
190×78×79cm(L*W*H)

HQ-5

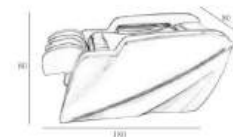

Name: Smart massage shampoo bed
Material: Yaris motor
Fiberglass enclosure, internal iron frame, Leather, wood, electric massage function

Carton and pallet packing size:
180*80*80cm(L*W*H)



HQ-2



Carton and pallet packing size:
189×82×80cm(L*W*H)



HQ-6

Carton and pallet packing size:
180*86*79cm(L*W*H)

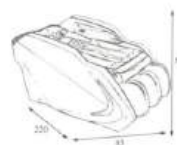

HQ-3

SIZE:
220×83×82cm(L*W*H)

The leg against the wall should be reserved :40cm
Drain outlet from the ground: 35cm
16cm
Height of iron frame below :13cm

HQ-7

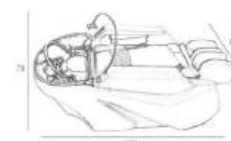

Carton and pallet packing size:
190*80*78cm(L*W*H)



HQ-4

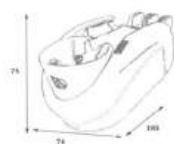

SIZE:
185 ×74×75cm(L* W*H)

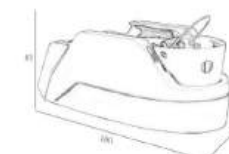

HQ-8

Carton and pallet packing size:
180*80*85cm(L*W*H)

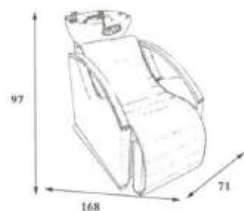

HQ-A282

SIZE:
168×71×97cm(L*W*H)

HQ-S112



Carton and pallet packing size:
20 ×60×110cm(L*W*H)



HQ-9

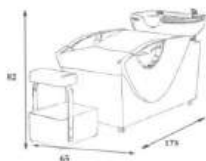

Carton and pallet packing size:
175×65 ×82cm(L*W*H)



HQ-12

Carton and pallet packing size:
145×63 ×84cm(L*W*H)



HQ-10

SIZE:
146×60×82cm(L*W*H)

HQ-13

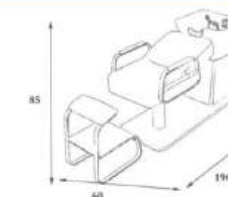

Carton and pallet packing size:
190 ×60×85cm(L*W*H)



HQ-11

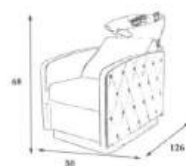

SIZE:
126 ×50×68cm(L*W*H)



HQ-14

Carton and pallet packing size:
165 ×65×99cm(L*W*H)

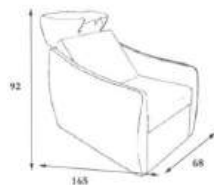

HQ-S114

SIZE:
165 × 68 × 92cm(L*W*H)

HQ-329

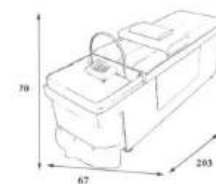

Carton and pallet packing size:
203 × 67 × 70cm(L*W*H)

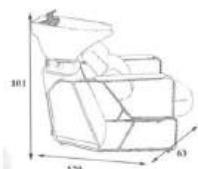

HQ-S111

Carton and pallet packing size:
120 × 63 × 101cm(L*W*H)

HQ-15

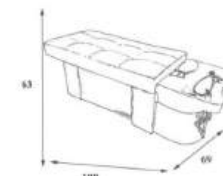

Carton and pallet packing size:
199 × 69 × 63cm(L*W*H)

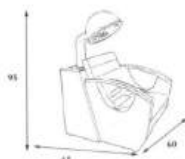

HQ-S113

SIZE:
65 × 60 × 95cm(L*W*H)

HQ-17

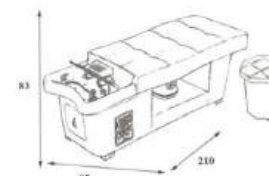

Carton and pallet packing size:
210 × 85 × 83cm(L*W*H)

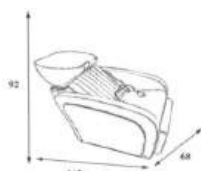

HQ-18

Carton and pallet packing size:
Size: 165 × 68 × 92cm(L*W*H)

HQ-16

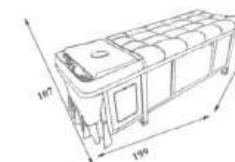

SIZE:
Size: 110 × 65 × 63cm(L*W*H)





HQ-19

SIZE:
198×94×69cm(L*W*H)

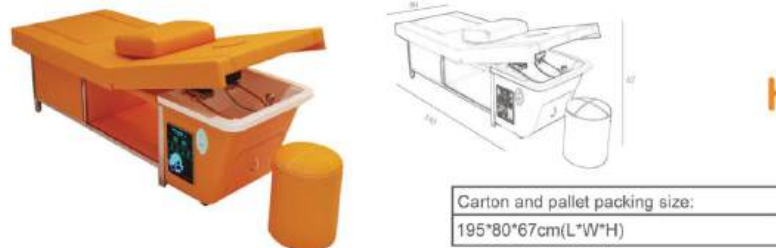

HQ-20

Carton and pallet packing size:
195*80*67cm(L*W*H)



HQ-21

SIZE:
200 × 70 × 70cm(L*W*H)



HQ-22

SIZE:
200×70× 70cm(L*W*H)



HQ-23



HQ-24



HQ-25



HQ-26



HQ-27



HQ-28



HQ-29



HQ-30



HQ-35



HQ-36



HQ-31



HQ-32



HQ-37



HQ-38



HQ-33



HQ-34



HQ-39



HQ-40



HQ-41



HQ-42



HQ-47



HQ-48



HQ-43



HQ-44



HQ-49



HQ-50



HQ-45



HQ-46

HQ-JZ1



HQ-JZ2



HQ-JZ5



HQ-JZ6



HQ-JZ3



HQ-JZ4



HQ-JZ7



HQ-JZ8

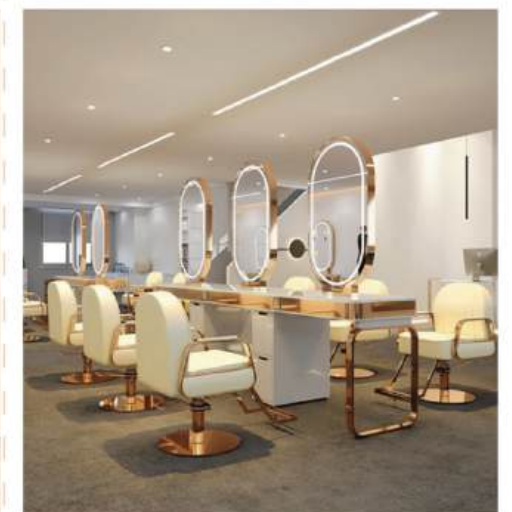

HQ-JZ9



HQ-JZ10



HQ-JZ13



HQ-JZ14



HQ-JZ11



HQ-JZ12



HQ-JZ15



HQ-JZ16





HQ-89901



HQ-89942



HQ-122



HQ-123



HQ-120



HQ-121



HQ-113



HQ-124





DR. EISSING & SOHN

HANDEL & SPEDITION KG

 +49 160 636 2588

 Erdbeerfeld 20, 26899 Rhede (EMS)

 www.eissing-sohn.de

 info@eissing-sohn.de

Für Anfragen zu Angeboten, Preisen und allen weiteren Anliegen:

 simon_uwe@eissing-sohn.de

